

Automation Equipment for Today's Pharmacy



PHARMACY AUTOMATION CATALOG

2020



Pharmacy Automation Systems

PAS-YUYAMA

QEM | **PAS**
Manufacturing | Machines

1-800-448-8768



Automation Equipment for Today's Pharmacy

QEM Inc. designs and manufactures innovative and affordable pharmacy automation equipment that improves workflow and helps speed up production. QEM is a certified ISO 9001:2015 company, a family owned and operated, and headquartered in Largo, Florida.

Our sister company Pharmacy Automation Systems distributes a full line of automation systems to accommodate low and high volume pharmacies. PAS was established by QEM, Inc. to fulfill a need in the pharmacy industry.

We are pleased to be a USA distributor of the Yuyama line of automated pharmaceutical equipment. As the world's largest pharmaceutical automation company, Yuyama offers the resources, experience and automation systems to improve safety and to speed up medication dispensing.

Besides its world class line of pharmacy automation equipment for Pharmacies, Hospitals and Long Term Care, Yuyama is praised for having some of the best Technical support and on-site service in the market. Yuyama knows how integral automation can be to the daily pharmacy operation and takes great pride in keeping their systems up and running reliably.

Our pharmacy automation catalog features pouch, vial and blister card filling systems for both small and large pharmacies.

To learn more about our pharmacy systems please visit our 3 automation websites or give us a call.

www.pharmacyautomationsystems.com

www.pas-yuyama.com

www.pasmachines.com

1-800-448-8768



Versi-Mate™



The Yuyama
BLIENT

yuyama
Line of Pharmacy Automation

Vial Filling Systems
Blister Card Filling Systems
Tablet Pouch Packaging Systems
Specialty Pharmacy Systems

Blister Card Filling Systems

pages

2. PAS - Versi-Mate™ – Semi-Automated Blister Card and Vial Filling
2. PAS - Versi-Fill® IIe - Automated Blister Card and Vial Filling
3. PAS - Versi-Pack Software
3. Yuyama - Blient - Semi-Automatic Blister Pack Solution
4. PAS - Blister Card Cold Sealing Machine
4. PAS - Platens, Bottle Pucks and Pill Canisters
5. PAS - Semi-Automatic Blister Card Fulfillment (Versi-Fill 2000)
5. PAS - Semi-Automatic Blister Card Fulfillment (Versi-Fill)

Tablet Pouch Packaging Systems

pages

6. Yuyama - Litrea III -112VerUC2 - Fully-Automatic Tablet Pouch Packager
6. Yuyama - Litrea III -112VerUC4 - Fully-Automatic Tablet Pouch Packager
7. Yuyama - Litrea III -136VerUC4 - Fully-Automatic Tablet Pouch Packager
7. Yuyama - Litrea III - Tab-Sight - Packed-Tablet Verification System
8. Yuyama - Proud 260 - Fully-Automatic Tablet Pouch Packager
8. Yuyama - Proud 336 - Fully-Automatic Tablet Pouch Packager
9. Yuyama - Proud 520 - Fully-Automatic Tablet Pouch Packager
9. Yuyama – Proud - Manual DTA Station & DTA Storage
10. Yuyama - Automatic Winder/Spooler

Vial Filling Systems

pages

11. PAS - Tech-Mate – Vial Filling System
11. PAS - Versi-Mate – Semi-Automated Blister Card and Vial Filling
12. PAS - Versi-Fill® IIe - Automated Blister Card and Vial Filling
12. PAS - Versi-Pack Software
13. Yuyama - EV-54 - Semi-Automatic Vial-Filling Machine
13. Yuyama - EV180UC - Fully-Automatic Vial-Filling Machine

Specialty Pharmacy Automation Systems

pages

14. CMD-60 and the CMD-300
14. On-Demand Document Inserter
15. Bottle Label Applicator
15. Automatic Packaging System
16. Semi-Automatic Packing System
16. High Density Shipping Sorter
16. Automatic Pill Dispensing (Lightning Pick)
16. Semi-Automatic Pill Dispensing (EV54-1)

Versi-Mate™

The Perfect Machine for Automating your Growing Pharmacy

From



Pharmacy Automation Systems



The **Versi-Mate** is a stand alone, barcode driven, table top pharmacy automation machine and uses external canisters to fill the prescription. Unlike most pharmacy automation this system fills vials, unit dose blister cards and multi-dose blister cards. It's small foot print makes it perfect for both small and large pharmacies.

- *Stand-Alone System*
- *No Daily Maintenance*
- *Fits on a Desktop*
- *Quick ROI*
- *Refill "On The Fly"*
- *Simple Touch Screen*



Fills Multi-Dose



Fills Unit-Dose



Fills Vials

For more information and to watch our videos:
www.pharmacyautomationsystems.com



Versi-Fill® IIe

The Perfect Machine for Automating your Growing Pharmacy

From



Pharmacy Automation Systems



The Versi-Fill IIe, is a stand alone pharmacy dispensing system that quickly fills vials, unit dose blister cards and multi-dose blister cards. The system holds 60 individual medication canisters and is expandable to 600 canisters. The Versi-Fill IIe will fill over 95% of all of the packaging used in the marketplace today.

- *Adds another layer of safety when dispensing medications*
- *Holds 60 Medication Canisters, Expandable to 600 Canisters*
- *Stand-Alone System, Software Interfacing is not a Requirement*
- *Touch Screen Walks User Through Every Step of the Operation*
- *Rugged Technology that's Easy to Use*



Vials Unit Dose Multi-Dose

For more information and to watch our videos:
www.pharmacyautomationsystems.com



Versi-Pack Software

The Perfect Software for Automating your Growing Pharmacy



The Versi-Pack software makes it easy to fill vials, unit dose and multi-dose blister cards and hand filled prescriptions quickly and accurately. The Versi-Pack dispensing software can also be used as a stand alone system for hand filling multi-dose and single dose blister card prescriptions.

Versi-Pack is a revolutionary pharmacy dispensing software that interfaces with Tech-Mate, Versi-Mate and Versi-Fill IIe. Versi-Pack also works perfectly with the CMD-300, our secure automated medication storage and dispensing system. It will keep track of the quantity of medications in each bottle and securely store and deliver those medications to you on demand.

- *Dispensing software that gets the job done fast and accurately*
- *Increase productivity without additional labor*
- *The Versi-Pack software adds another layer of safety when dispensing prescriptions with checks and balances*

For more information and to watch our videos:
www.pharmacyautomationsystems.com



BLIENT

Semi-Automatic Blister Pack Solution



Yuyama has finally created a blister pack solution for all blister packs. In the U.S.A, single dose and multi-dose blister packs are being produced by many different manufacturers.

Most manufacturers filling systems will only use that companies specific single dose and multi-dose blister packs but the "Blitent" can adapt and will automate any manufacturers blister cards.



Expandable Number of Canisters, up to 520



Multi-Dose and Single Dose Available



Dual Operation to help to minimize down-time

For more information and to watch our videos:
www.pas-yuyama.com

From



Pharmacy Automation Systems

Blister Card Cold Sealing Machine

Looking for the Perfect Seal for your Cold Seal Blister Cards?



If you're filling cold seal multi-dose blister cards and unit dose blisters cards our cold sealing machine saves you time and always produces the exact amount of pressure for a perfectly sealed blister card. No more aching hands (repetitive stress injuries) and get the perfect seal every time with the cold sealing machine from Pharmacy Automation Systems.

- *It Perfectly Seals each Card in One Motion*
- *Sealing with a Hand Roller is Time Consuming and Tedious*
- *It's Easily Adjustable for the Thickness of your Card*
- *Just One Pass will Securely Seal your Cold Seal Card*
- *Rubber Suction Feet Assure that it won't Slide During the Seal*
- *It's all Metal Construction will Provide Years of Trouble Free Use*

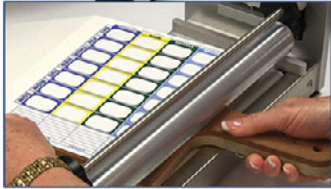

Quickly Seals Multi-Dose Blister Cards



Perfectly Sealed Unit Dose Cards

For more information and to watch our videos:
www.pharmacyautomationsystems.com



Platens

Stock
& Custom

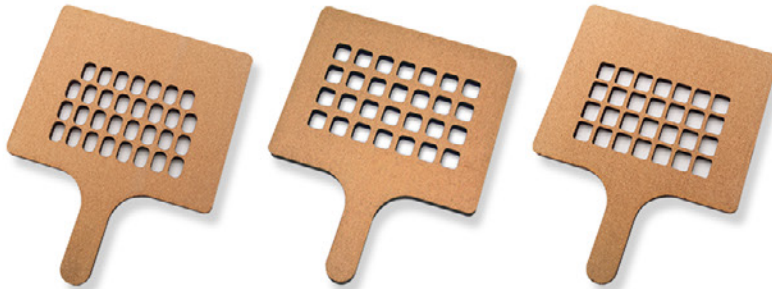

We design and produce a full line of stock and custom made platens for both unit dose and multi-dose blister cards.

Give us your blister card specs and we'll produce the perfect platen to fit your card.



Pucks

A vehicle to transport bottles on a conveyor providing stability, the ability to have the top of different sized bottles at a constant height above the conveyor, and a place to attach an RFID tag.



Canisters

The canisters are used with PAS pill dispensing equipment. The pills are contained in a durable, high impact polycarbonate material and are custom machined for each pill type here in the USA.

Specifications: Pill capacity - 600cc or 1,500cc, Staffing - 0

Semi-Automatic Blister Card Fulfillment (Versi-Fill 2000)

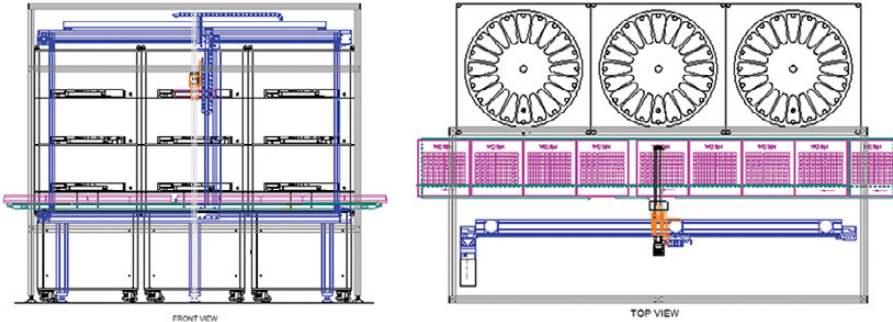

One technician prepares an empty blister card for filling and places it into an infeed queue. The Versi-Fill 2000 will automatically fill the blister card. Another technician will remove the blister cards from the output queue and finish off the card. Feeding and retrieving cards is not a fulltime job so idle time is used to replenish and switch out the canisters. When not at peak demand, one technician can operate the workstation.

Specifications:

- 480 medications (180 active at any one time)
- Single or multidose blister cards - maximum of 2,000 in 8 hours
- Staffing - 2
- Footprint - 20'- 0" x 13'- 0" = 260 sq. ft.

For more information and to watch our videos:
www.pharmacyautomationsystems.com



Semi-Automatic Blister Card Fulfillment (Versi-Fill)



The technician prepares the empty blister card for filling, places it in a platen, and scans the barcode identifying the prescription. A light will be lighted that identifies the slot for the placement of the platen. Once the platen is inserted into the slot, the blisters will be filled (single dose or multidose). While the blister cards are being automatically filled, the technician can prepare another platen or finish off a platen that has already been filled in the Versi-Fill.

Specifications:

- 600 medications (60 active at any one time)
- Unit or multidose blister cards - maximum of 900 in 8 hours
- Staffing - 1
- Footprint - 2'- 6" x 2'- 6" = 6.25 sq. ft.



LITREA III 112VERUC2

The Fully-Automatic Tablet Pouch Packager



From
PAS-yuyama

Litrea III is the perfect solution for small to middle sized pharmacies. Yuyama's fully-automatic pouch filling tablet packager is the newest technological innovation, it's a 2 station Universal Canister solution for increasing brand-to-generic drug changes. 60 pouches per minute and holds 112 canisters.

Let Litrea III help improve your patients' medication compliance.



DTA Tray Function for Manual Fills



RFID Function



Verification Process for the Drug Replenishment

For more information and to watch our videos:
www.pas-yuyama.com

LITREA III 112VERUC4

The Fully-Automatic Tablet Pouch Packager



From
PAS-yuyama

Litrea III is a fully-automatic pouch filling tablet packager from Yuyama. It's a 4 station Universal Canister solution for increasing brand-to-generic drug changes and is Yuyama's newest technological innovation,. It holds 112 canisters and fills 60 pouches per minute.

This Litrea III, fully-automatic pouch filling system is the perfect solution for small to middle sized pharmacies.



Universal Canister (Optional)



Half-Cutter Function (Optional)



Automatic 4-Color Penliner (Optional)

For more information and to watch our videos:
www.pas-yuyama.com

LITREA III 136VERUC4

The Fully-Automatic Tablet Pouch Packager



From
PAS-yuyama

If you own a small or middle sized pharmacy then the Litrea III is the perfect sized solution for you. This fully-automatic pouch filling tablet packager from Yuyama is it's newest innovation. It features a Universal Canister solution for increasing brand-to-generic drug changes. It holds 136 canisters and will fill 60 pouches per minute.

Litrea III will improve your patients' medication compliance.



Universal Canister (Optional)



RFID Function



Verification Process for the Drug Replenishment

For more information and to watch our videos:
www.pas-yuyama.com

LITREA III Tab-Sight

Packed-Tablet Verification System



From
PAS-yuyama

Tab-Sight can efficiently inspect the packed tablets for color, quantity and shape by utilizing data from the packager device. Users can easily check the result for each pouch on the large screen.

As an option, Yuyama also provides the marking function for inaccurate pouches. Users can check the marked pouches after verification, making this the best solution for patient safety.



Large Screen Visual Check

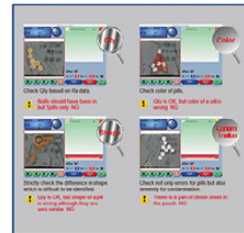

Pouch Results Verification



Easy Operation

For more information and to watch our videos:
www.pas-yuyama.com

From

PAS-YUYAMA

PROUD 260

The Fully-Automatic Tablet Pouch Packager



Set your goals higher and change what it means to be a pharmacist. The Proud tablet pouch packager was developed based on the requests from pharmacists, to make it completely customer-oriented.

The Proud excels above all others in accuracy, quality, safety, and functionality, it also adds efficiency and reliability to your workflow. The Proud offers a small foot print with it's multi-carousel design, and has 5 configurations depending on your needs. 60 pouches per minute and holds 260 canisters.



Allocate Medication with Barcode and RFID



Customer-Oriented Function Pouch Sizes



DTA Tray Function for Manual Fills

For more information and to watch our videos:

www.pas-yuyama.com

From

PAS-YUYAMA

PROUD 336

The Fully-Automatic Tablet Pouch Packager



This Proud 336 fully-automatic tablet pouch packager was developed for pharmacists who wanted to fill prescriptions quickly and accurately.

The Proud has a small foot print and a multi-carousel design, the packager has 5 configurations depending on your needs. It fills 60 pouches per minute and holds 336 canisters. The Proud excels in accuracy, quality, safety, and functionality, it also encourages efficiency and provides a reliable workflow.



RFID Function



Half-Cutter Function (Optional)



Easy Accessibility of Packing Unit

For more information and to watch our videos:

www.pas-yuyama.com

From

PAS-YUYAMA

PROUD 520

The Fully-Automatic Tablet Pouch Packager



The Proud tablet pouch packager was developed for accuracy, quality, safety, and functionality. This packager also encourages efficiency and reliability to your workflow.

The Proud offers a small foot print at only 70 inches wide and 78 inches tall. This system has a multi-carousel design, and has 5 pouch size configurations depending on your needs. The Proud will fill up to 60 pouchs per minute and holds 520 medication canisters to keep you up and running non stop all day long.



Allocate Medication with Barcode and RFID



RFID Function



Customer-Oriented Function Pouch Sizes

For more information and to watch our videos:

www.pas-yuyama.com

PROUD DTA STATION & DTA STORAGE

From

PAS-YUYAMA



Human error during manual-fills is a very common issue in this industry. To assist with this issue, Yuyama has developed this support system for manual-filling. Users prepare manual medication trays by following the LED lights and on-screen guidance from the connected work station. Users can easily understand where the drugs should be placed.

With the Pharmacy Intergrated Software, only prescriptions needing manual fills will be sent to the software separately. The pharmacist then prepares the manual medications in advance. At the same time, the system can print out the list of manually added drugs for added efficiency and improving their overall manual preparation.



DTA Station



DTA Storage



Software for Manual Fills

For more information and to watch our videos:

www.pas-yuyama.com

AUTOMATIC WINDER/SPOOLER

Winding Pouches has never been easier

From

PAS-YUYAMA



Yuyama provides a fully-automatic winder for reducing time spent on manual pouch organization. The compact winder can organize a large amount of pouch strips from packager devices automatically.

Once you attach the edge of the pouch strip into the spooler, the winder will automatically begin operation, promoting efficiency in your workflow.



Connect with the Tab-Sight for Added Patient Safety



Connect to our Packers for Time Savings

For more information and to watch our videos:

www.pas-yuyama.com

PROUD
Tablet Pouch Packaging



PAS-YUYAMA



EV180UC
Vial Filling Automation

Tech-Mate®

The Perfect Machine for Automating your Growing Pharmacy

From



Pharmacy Automation Systems



The **TECH-MATE**: is a 60 canister, stand alone, barcode driven vial filling system. It is expandable up to 600 canisters utilizing the external canister option. It is designed for easy installation, training and operation and has a floor footprint of approximately 3' (w). x 3' (d) x 6' (h).

- *Reduce your dispense time thereby saving labor hours every day*
- *The Tech-Mate accommodates most vials on the market so you are not tied down to a particular vial manufacturer*
- *Simple Touch Screen*
- *Unique feature allows canister refilling "on the fly"*



Fills Vials

For more information and to watch our videos:
www.pharmacyautomationsystems.com



Versi-Mate™

The Perfect Machine for Automating your Growing Pharmacy

From



Pharmacy Automation Systems



The **Versi-Mate** is a stand alone, barcode driven, table top pharmacy automation machine and uses external canisters to fill the prescription. Unlike most pharmacy automation this system fills vials, unit dose blister cards and multi-dose blister cards. It's small foot print makes it perfect for both small and large pharmacies.

- *Stand-Alone System*
- *No Daily Maintenance*
- *Fits on a Desktop*
- *Quick ROI*
- *Refill "On The Fly"*
- *Simple Touch Screen*



Fills Vials



Fills Unit-Dose



Fills Multi-Dose

For more information and to watch our videos:
www.pharmacyautomationsystems.com



Versi-Fill[®] IIe

The Perfect Machine for Automating your Growing Pharmacy



Pharmacy Automation Systems



The Versi-Fill IIe is a stand alone pharmacy dispensing system that quickly fills vials, unit dose blister cards and multi-dose blister cards. The system holds 60 individual medication canisters and is expandable to 600 canisters. The Versi-Fill IIe will fill over 95% of all of the packaging used in the marketplace today.

- Adds another layer of safety when dispensing medications
- Holds 60 Medication Canisters, Expandable to 600 Canisters
- Stand-Alone System, Software Interfacing is not a Requirement
- Touch Screen Walks User Through Every Step of the Operation
- Rugged Technology that's Easy to Use



Vials Unit Dose Multi-Dose

For more information and to watch our videos:
www.pharmacyautomationsystems.com



Versi-Pack Software

The Perfect Software for Automating your Growing Pharmacy



Pharmacy Automation Systems



The Versi-Pack software makes it easy to fill vials, unit dose and multi-dose blister cards and hand filled prescriptions quickly and accurately. The Versi-Pack dispensing software can also be used as a stand alone system for hand filling multi-dose and single dose blister card prescriptions.

Versi-Pack, is a revolutionary pharmacy dispensing software that interfaces with Tech-Mate, Versi-Mate and Versi-Fill IIe. Versi-Pack also works perfectly with the CMD-300, our secure automated medication storage and dispensing system. It will keep track of the quantity of medications in each bottle and securely store and deliver those medications to you on demand.

- Dispensing software that gets the job done fast and accurately
- Increase productivity without additional labor
- The Versi-Pack software adds another layer of safety when dispensing prescriptions with checks and balances

For more information and to watch our videos:
www.pharmacyautomationsystems.com



EV-54

Semi-Automatic Vial-Filling Machine



From
PAS-yuyama

The EV-54 holds 54 factory calibrated 900cc canisters. This device is very simple and user-friendly. This system is highly recommended by our customers, capable of filling in excess of 100 prescriptions per hour in a compact 57"W x 12"D x 75"H frame.



Exclusive Factory-Calibrated Canisters



Directly Fills from Drug Cassettes



Movable Touch Screen and Barcode Reader

For more information and to watch our videos:
www.pas-yuyama.com

EV1 80UC

Fully-Automatic Vial-Filling Machine



From
PAS-yuyama

The Universal Canister is the solution for generic medication filling. The canister enables users to dispense various medications after calibration. It means that pharmacists no longer need to order the additional canisters for sudden generic-brand changes. By automating 180 of your fastest-moving oral solid medications, the EV-180UC accurately fills and labels 500+ prescriptions or more per day, or 50% of countable oral solid volume.



Universal Canister that can Calibrate Itself



Drug Imaging Station that Photographs Meds

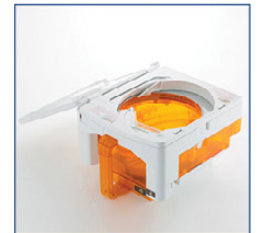

Calibration and Replenishment Station

For more information and to watch our videos:
www.pas-yuyama.com

CMD-60 & CMD-300

The Perfect Machines for Automating your Growing Pharmacy

From



Pharmacy Automation Systems



The **CMD-60 and CMD-300** are secure automated medication storage and retrieval systems that will free up valuable medication shelf space, keep track of the quantity of medications in each bottle and securely store and deliver those medications to you on demand.

This system will store up to 60 bulk medication containers in the CMD-60 and 300 bulk medication containers in the CMD-300, freeing up valuable shelf and pharmacy storage space.

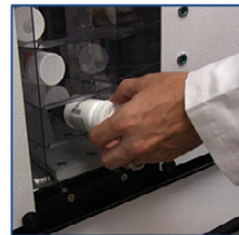

Adjustable Compartments for Compact Storage



Light Directed Inventory put Away



Barcode Scanning during Dispensing

For more information and to watch our videos:
www.pharmacyautomationsystems.com



On-Demand Document Inserter

Improved Service & Efficiency through Automation

From

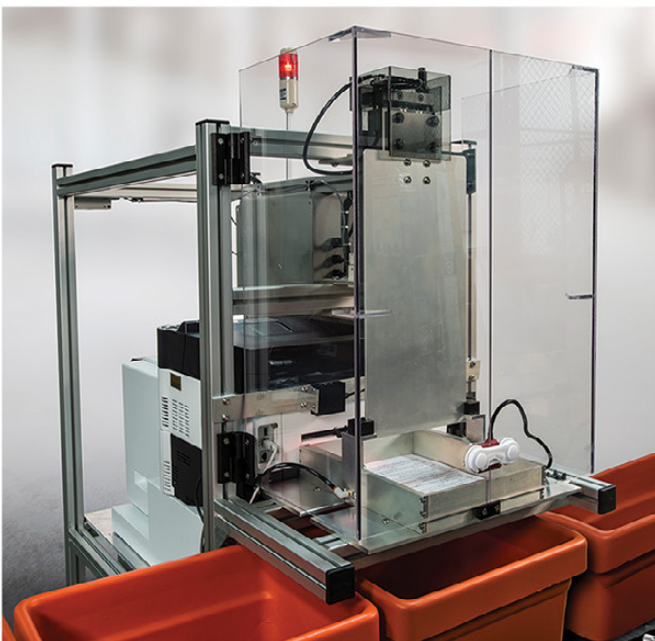

The **On-Demand Document Inserter** performs document print on demand and precision placement of documents into an open carton or tote.

Our On-Demand Document Inserter employs an Industrial Printer with a 2000 Sheet Paper Supply for fast on-demand printing. With On-Demand printing you'll always have the latest version documents inserted into your carton or tote.

The barcode on the document packet is matched to the RF tag on the tote to ensure accuracy.

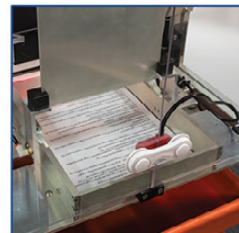

Pneumatic Air Cylinder Inserts the Patient Doc



RFID Tech for Reading and Sending the Tote ID

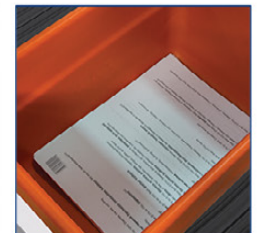

Last Page Printed has a Barcode Identifier on it

For more information and to watch our videos:
www.pasmachines.com



Bottle Label Applicator

Improved Service & Efficiency through Automation

From
QEM | **PAS**
Manufacturing | Machines

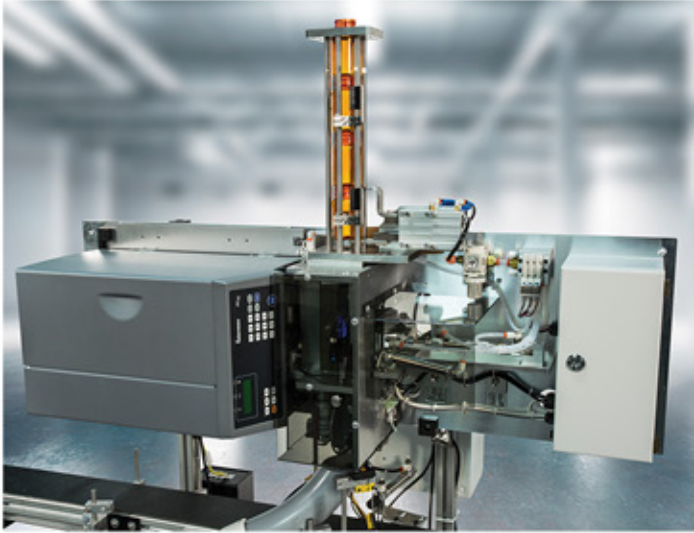

This Bottle Label Applicator automatically prints the label and then automatically adheres the labels on a variety of different bottle sizes.

A true workhorse, our bottle label applicator is one of the most reliable labeling machines in its class. If speed and dependability are important to you then check out this bottle label applicator exclusively from PAS Machines.



Labels 900 Bottles Per Hr
Speeds of 4" to 8" Per Sec



Bottle diameters from
1.75" to 2.50"



Bar Code Reader Option

For more information and to watch our videos:
www.pasmachines.com



Automatic Packaging System

Improved Service & Efficiency through Automation

From
QEM | **PAS**
Manufacturing | Machines



Arriving prescription bottles are automatically scanned and placed into a shipping package. The scanning of the first bottle causes the document packet to be printed, the shipping label to be printed on the bag, and the opening of the bag to receive the bottles.

When the document packet has been printed, all the bottles in the order are scanned, the shipping label is scanned, the bottles are inserted into the bag. The bag is then automatically sealed and dropped onto a conveyor to be taken to shipping.



1 to 4 Bottles per Order

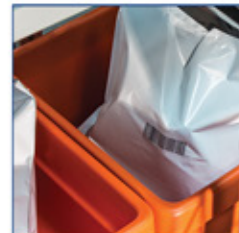

Packs a Maximum of 1800,
4 Page Orders in 8Hrs.



For more information and to watch our videos:
www.pasmachines.com



Semi-Automatic Packaging System

When the operator scans the order identifying barcode on the document set the shipping label is automatically printed on the shipping bag. Next, the bag is automatically opened to receive the documents and the medications. Then, the operator inserts the document packet, scans each of the medications and places them into the bag. Finally, the operator pushes a button or a foot pedal to seal the bag so it can be sent to shipping. It is important to note that the bag will only seal if the documents and all of the medications have been correctly scanned.

Specifications: • Medications per bag – 10 • Packages – maximum of 1,600 in 8 hours • Staffing – 1 • Footprint – 5'- 6" x 3'- 6" = 19.25 sq. ft.

From
QEM **PAS**
Manufacturing | Machines

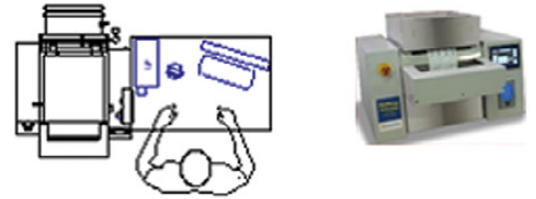

High Density Shipping Sorter

Sorts packages into shipping totes.

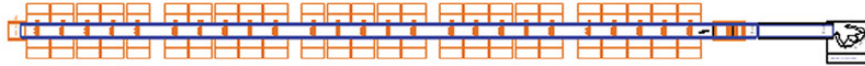

Specifications:

- Maximum of 240 sort points (100 shown here)
- Packages – maximum of 7,000 in 8 hours
- Staffing – 1
- Footprint (100 sort points) - 70'- 0" x 6'- 0" = 420 sq. ft.

Automatic Pill Dispensing (Lightning Pick)

A fully automatic work station that dispenses medication into arriving bottles in pucks.

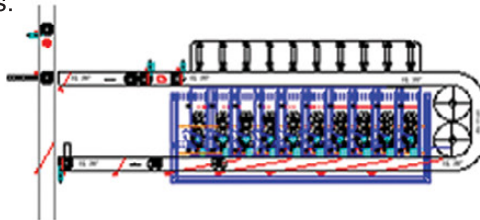

Specifications:

- 10 medications active at any one time.
- Prescriptions – maximum of 10,000 in 8 hours
- Staffing – 0
- Footprint - 10'- 0" x 3'- 6" = 35 sq. ft.

Semi-Automatic Pill Dispensing (EV54-1)

Labeled empty bottles arrive in pucks. As pucks enter the queue of empty bottles, the appropriate pill counter dispenses the prescription. Once the empty bottle reaches the technician, at the head of the queue, it is removed from the puck and scanned. This causes a light adjacent to the pre-counted medication to be lighted. The technician then retrieves the pills, scans the patient barcode on the bottle, places the filled prescription into the puck and pushes the puck back out onto the conveyor.

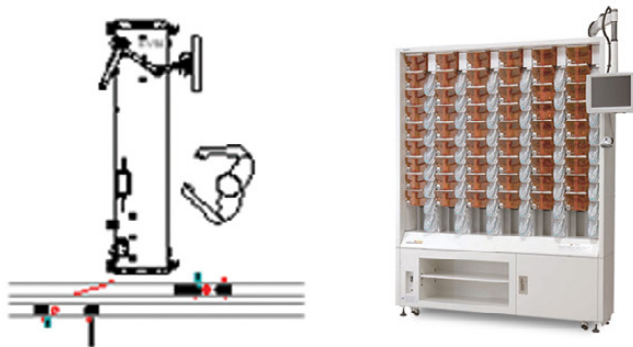

Specifications:

- 54 medications
- Prescriptions maximum of 1,700 in 8 hours
- Staffing – 1
- Footprint - 6'- 6" x 2'- 6" = 16.25 sq. ft.

For more information and to watch our videos:
www.pasmachines.com



QEM **PAS**
Manufacturing Machines

Bottle Label Applicator

- Labels 900 Bottles Per Hr.
- Bottle Diameters from 1.75" to 2.50"
- Bottle Barcode Readers Optional

Intermec

PX4i



Automation Equipment for Today's Pharmacy

PHARMACY **AUTOMATION** **CATALOG**

**Automation Equipment
for Today's Pharmacy**

Phone 1-800-448-8768



Pharmacy Automation Systems

PAS-yuyama

QEM | **PAS**
Manufacturing | Machines

This catalog is for reference only and is subject to change without notice. (Revised 4/2020)

Pharmacy Automation Systems, LLC • 8790 66th Court N., Pinellas Park, FL 33782